



INNOVATING HOSPITALITY INTERIOR DESIGN,  
PROCUREMENT & MANUFACTURING



INTERIOR DESIGN



PROCUREMENT



MANUFACTURING



MILLWORK SOLUTIONS

## ABOUT US

JM Hospitality Solutions LLC (JMHS) was founded in 2018 by Jimmy Macwan . Our company offers comprehensive hospitality management services, including in-house interior design, procurement and manufacturing. We use our industry experience, service expertise, and geographic reach to deliver FF&E projects nationwide. Our team works with clients to create stunning interiors that meet their goals, schedules, and budgets. We review project information to build a detailed and precise project scope, source the best products, and offer expert recommendations on product suitability and cost-effectiveness. Our focus on customer service, attention to detail, and unique approach set us apart in the industry.



# JMHS FLOW

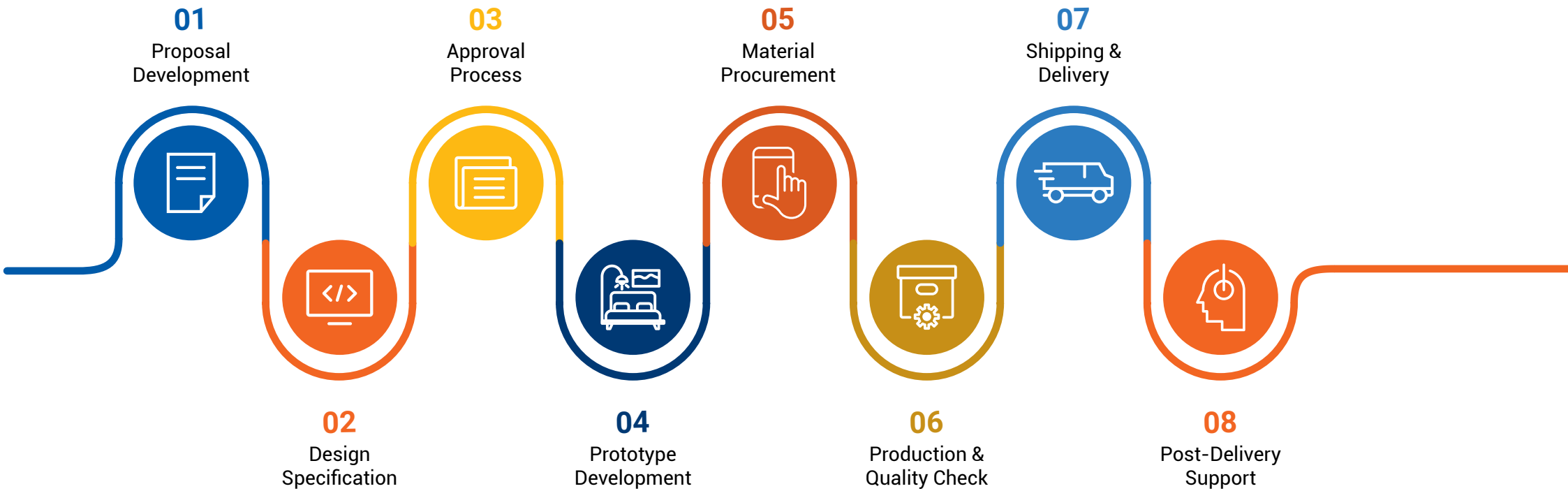

# OUR SERVICES



## INTERIOR DESIGN

Delivering bespoke interior design solutions that capture the essence of each client's vision, budget, and time-line since 2018.



## PROCUREMENT

Leverage a vast network of suppliers and manufacturers to ensure timely and cost-effective procurement of top-quality materials and products.



## MANUFACTURING

We give tailored manufacturing solutions for furniture, fixtures, and equipment that cater to our client's specific needs and preferences.



## MILLWORK SOLUTIONS

We are dedicated to delivering top-notch millwork solutions that blend artistry with functionality.

# INTERIOR DESIGN SERVICES

## Specification Review

JMHS offers quality while reviewing specs & budgets to identify cost-saving opportunities. We provide a detailed, itemized budget, automated cost comparisons, vendor recommendations & comprehensive reporting to keep you informed throughout the process.



## Brand Submittal

We meticulously compile and organize all documentation per each brand's specific standards. We work with brand reviewers to ensure your design meets requirements and make any necessary adjustments for a successful outcome.



## Renders

Our 3D models explore design styles, finishes, and influences through schematic drawings. These visual representations highlight the volumetric aspects of your design based on your selections.



# INTERIOR DESIGN PROCESS



## Research & Analysis

We thoroughly analyze your property and brand to ensure we understand your requirements and preferences.

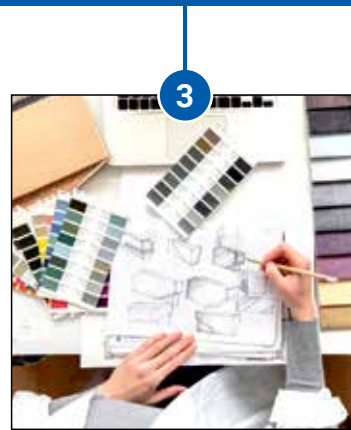

## Design Development

We create a design plan incorporating your brand and design preferences while considering functionality and budget constraints.

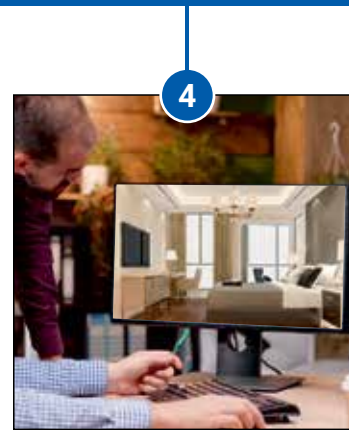

## 3D Rendering Images

Our team uses the latest software to produce realistic 3D rendering images of your space, allowing you to visualize the final design.



## Documentation & Submittal

We produce detailed documentation of the design plan and submit it to relevant parties, ensuring that all necessary approvals are obtained before proceeding with the project.

# PROCUREMENT SERVICES

## Procurement Analysis

We analyze your project requirements to build a clear and concise scope while considering quality, cost, and delivery time. Our value engineering approach helps us uncover alternative options to meet your budget and goals. We leverage our vast network of suppliers and purchasing power to source the best products for your project.



## Project Management

At JM Hospitality, our dedicated Project Manager oversees every aspect of the FF&E procurement process, from project scope to site installation. We prioritize effective communication to ensure a transparent and successful project. Trust us to manage your project with professionalism, expertise, and a commitment to your vision.



## Bidding & Purchasing

From negotiating with suppliers to issuing purchase orders, we handle every step of the FF&E purchasing process. Our cloud-based reporting ensures transparency throughout the procurement process, and we collaborate with logistics partners to schedule cost-effective transportation and warehousing. You'll receive real-time updates to stay informed every step of the way.



# PROCUREMENT PROCESS



1

## Project Kick-Off

Collaborative planning to define project goals, objectives, and timelines.



3

## Timeline Check

Ensuring project milestones are met on time, reducing the chance of delays.

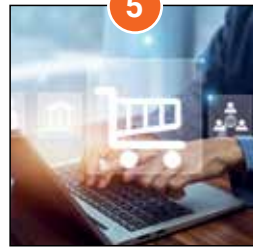

5

## Purchasing Management

Managing supplier relationships and issuing purchase orders and invoices.



7

## Delivery & Installation Analysis

Assessing site readiness and coordinating delivery and installation.



9

## Final Inspection

A thorough review of the installation to ensure compliance with design requirements and specifications.



2

## Comprehensive Budget Analysis

A detailed assessment of project costs and spending.



4

## Model Room

Creating a prototype room to test design concepts and evaluate the final product.



6

## Product Tracking & Logistics

Managing the flow of products to ensure timely delivery.



8

## Installation Reporting

Detailed reporting ensures installation is completed according to design specifications.

# MANUFACTURING SERVICES



## Line Drawings

Experience accurate and detailed line drawings that capture every essential detail of your case goods, soft seating, and lighting. Our team collaborates with our overseas manufacturer to bring you the best.

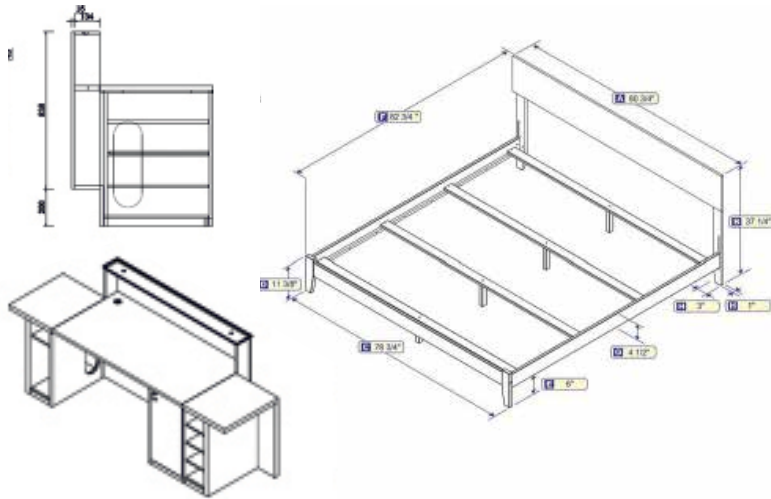

## Sampling

Get a sneak peek of the final product before it's even produced. Our manufacturer creates a set of samples for your property, allowing you to make any final adjustments to ensure the perfect outcome.



## Quality Assurance

We don't compromise on quality. Our logistics team works tirelessly to ensure every piece is delivered to your satisfaction. We provide detailed documentation, including production pictures and pack-slip, to guarantee quality control and give you peace of mind.

# MANUFACTURING PROCESS



## Collaborate with client and share pricing

We collaborate with clients and provide transparent pricing throughout the manufacturing process.

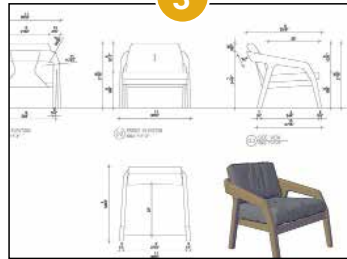

## Provide detailed shop drawings

Our inhouse team provides detailed drawings to ensure accuracy and precision in the manufacturing process.



## Provide progress photos of all products

Clients receive progress photos of all products to ensure quality and accuracy.



## Acknowledgment & key steps & dates

We regularly update clients on critical steps and dates.

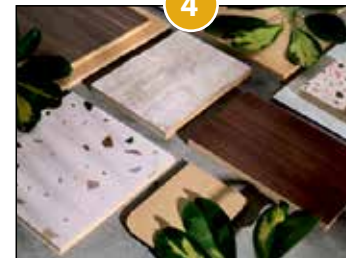

## Provide JMHS standard finish samples

We provide clients with JMHS standard finish samples to ensure their vision is executed flawlessly.



## QA and Delivery to the customer

We provide thorough QA and Delivery, ensuring complete product satisfaction.



## MILLWORK SOLUTIONS

### Custom Designs

Tailored solutions for residential, commercial, and hospitality spaces. Our skilled craftsmen collaborate closely with clients to bring their unique visions to life.



### Turn-Key Solutions

Comprehensive services from concept to completion, ensuring a seamless and hassle-free experience for our clients.

### High-Quality Materials

We use only the finest woods, metals, and a variety of premium materials, ensuring durability and a timeless aesthetic.

## Made in the USA

Combining traditional craftsmanship with modern technology, we create pieces that are both beautiful and functional.



## High-Quality Materials

We use only the finest woods, metals, and a variety of premium materials, ensuring durability and a timeless aesthetic.



## MAKING CLIENTS HAPPY

We are very fortunate to have formed excellent partnerships with many of our clients. And we've formed more than just working relationships with them; we have formed true friendships. Here's what they're saying about us.



"The team at JM Hospitality was extremely professional, patient, and helpful throughout our search. They were outstanding and made one part of my job so much easier by taking the risk."

**Chitan Patel**  
CEO & President  
of Arris Hospitality



"JM Hospitality has allowed us to negotiate even better prices than we already had! In addition, they offer personal service and advice which facilitates our daily routine."

**Mehul Patel**  
CEO & President  
Magnolia Hospitality Group



"JM Hospitality is an excellent partner when it comes to purchasing. I only need to inform them about which suppliers and products I work with and they will search for the product with the right price/quality balance. It saves me."

**Ketan Patel**  
Owner  
Holiday INN Express



Jimmy and his team provided outstanding project assistance. Our project was complex, requiring collaboration with the brand design team and unique customizations, all while maintaining cost-effectiveness through value engineering. Folks at JMHS delivered excellent services to exceed our expectations and we look forward to doing other projects in the near future.

**Mr. Janak Patel**  
Owner  
Wingate Greensboro, NC



# WHY CHOOSE JMHS

Choosing JM Hospitality Solutions means you can trust that your project will be handled with professionalism, expertise, and personalized attention. With over 10 years of experience in the hospitality industry, our team has the knowledge and skills to ensure your project is completed on time, within budget, and to the highest quality standards.

Effective communication is critical to a successful project, and we maintain a clear and transparent channel throughout the process. Our team works closely with clients to ensure that their specific needs and goals are met, and we provide regular progress updates to keep them informed every step of the way.

At JMHS, we are dedicated to providing exceptional service and exceeding our client's expectations. Choose us for your next project and experience the JMHS difference.

- **With our in-house design team we commit to quality assurance throughout the process.**
- **Value engineering approach to uncover alternative products and materials as needed to meet your budget and goals.**
- **Procurement process focussed on sourcing the best products for your project while keeping costs in mind.**
- **Detailed documentation and progress photos provided to ensure project completion to exact specifications**
- **Extensive supply chain used to source products.**
- **Experienced team dedicated to effective communication and project management.**

100+ SATISFIED CUSTOMERS

• DECADES OF INDUSTRY EXPERIENCE

• ONE STOP SOLUTION FOR ALL FF&E PRODUCTS



## Save Big with Direct Factory Pricing

Enjoy unbeatable value by sourcing premium furniture directly from the factory, cutting out middlemen for maximum savings.



## Get Your Quote Fast - No Delays

Receive a detailed project quote within 24 hours, ensuring your project stays on track without unnecessary waiting.



## Trusted by Over 150 Premium Hotel Owners

Join a community of satisfied hotel owners who trust JMHS for exceptional quality, service, and design expertise.



## Expert Project Management

Benefit from professional project management services, guiding your project seamlessly from start to finish.



## After Sales Support

Our commitment doesn't end with the deal. We're here to assist you throughout the process and continue to provide support even after the project is complete.

# COMPLETED PROJECTS

## BEST WESTERN HOTELS & RESORTS

- Best Western - Seagoville, TX
- Best Western - Kansas City, MO
- Best Western - Thackerville, OK
- Best Western Plus - Raleigh, NC
- Best Western Plus - Jacksonville, FL

## BOUTIQUE HOTEL

- The Bridges - Natchez, MS
- Hotel Laurel - Watkins Glen, NY
- Hotel Alice - Pine Knoll Shores, NC

## CHOICE HOTELS

- Comfort Suites - Fort Worth, TX
- Comfort Suites - Nashville, TN
- Comfort Suites - Greenville, NC
- Comfort Suites - Myrtle Beach, SC
- Comfort Suites - Lumberton, NC
- Comfort Suites - Lawton, OK
- Comfort Suites - Kingsland, GA
- Comfort Inn & Suites - Bossier City, LA
- Comfort Inn & Suites DFW - Irving, TX
- Comfort Inn & Suites - Lubbock, TX
- Comfort Suites - Humble, TX
- Comfort Suites - Sanford, NC
- Comfort Suites - Bossier City, LA
- Comfort Suites - McKinney, TX
- Comfort Inn - Balch Spring, TX
- Sleep Inn Mainstay - Dallas, TX
- Sleep Inn - Conway, SC
- Sleep Inn - Baton Rouge, LA
- Clarion Pointe - Wake Forest, NC
- Clarion Hotel - Fayetteville, NC
- Clarion Pointe - High Point, NC
- Quality Inn & Suites - Waco, TX
- Quality Inn & Suites - Mesquite, TX
- Econo Lodge - Havelock, NC
- Econo Lodge - Morehead City, NC
- Econo Lodge - Saint George, SC
- Country Inn & Suites - Midway, FL
- Country Inn & Suites - Hinesville, GA
- Country Inn & Suites - Savannah Gateway, GA
- Country Inn & Suites - Lewisville, TX
- Country Inn & Suites - Roanoke Rapids, NC
- Country Inn & Suites - Shelby, NC
- Mainstay - Hickory, NC

## CHOICE ASCEND BOUTIQUE COLLECTION

- The Angler - Livingston, TX
- Hotel Vue - Natchez, MS
- The Carrier - Newport News, VA
- Tanglewood Resort - Pottsboro, TX

## HEALTHCARE FACILITY

- NovaCare Medical - East Bridgewater, MA

## HILTON HOTELS & RESORTS

- DoubleTree - Fort Worth, TX
- DoubleTree - Westchase, TX
- Home2 Suites - Raleigh, NC
- Home2 Suites - Dallas, TX
- Home2 Suites - Fort Lauderdale, FL
- Home2 Suites - Big Spring, TX
- Tru by Hilton - Dallas, TX
- Tru by Hilton - Wake Forest NC
- Hampton Inn - Victoria, TX
- Hampton Inn & Suites - Cleburne, TX
- Hampton Inn & Suites - Albemarle, NC
- Hampton Inn & Suites - Brookhollow, TX
- Hampton Inn & Suites - Havelock, NC
- Hampton Inn & Suites - Waxahachie, TX
- Hampton Inn & Suites - Palestine, TX
- Hampton Inn & Suites - Big Spring, TX
- Hampton Inn & Suites - Mountain View, CA
- Hampton Inn & Suites - Tomball, TX
- Homewood Suites - Coppell, TX

## HYATT HOTELS

- Hyatt House - Baltimore, MD

## IHG HOTELS & RESORTS

- Hotel Indigo - Durham, NC
- Candlewood Suites - White Settlement, TX
- Candlewood Suites - Wake Forest, NC
- Holiday Inn - Kansas City, MO
- Holiday Inn - Rock Hill, SC
- Holiday Inn Express - Kansas City, MO
- Holiday Inn Express - Waycross, GA
- Holiday Inn Express - Roanoke Rapids, NC
- Holiday Inn Express - Hiawassee, GA
- Holiday Inn Express - Dallas, TX
- Holiday Inn Express - Kenedy, TX
- Holiday Inn Express - Floresville, TX
- Atwell Suites - Fort Worth, TX

## MARRIOTT

- Four Points - Cary, NC
- Courtyard - Mt Arlington, NJ
- Courtyard - Monroeville, PA
- Residence Inn - Shreveport, LA
- Residence Inn - Waxahachie, TX
- TownePlace Suites - Boone, NC
- TownePlace Suites - Baton Rouge, LA
- TownePlace Suites - Weatherford, TX
- Spring Hill Suites - Durham, NC
- Fairfield Inn & Suites - Rocky Mount, NC
- Fairfield Inn & Suites - Charleston, SC
- Aloft - Dallas, TX

## WYNDHAM HOTELS & RESORTS

- La Quinta - Selma, NC
- La Quinta - Raleigh, NC
- La Quinta - Jacksonville, FL
- La Quinta Inn & Suites - Mesquite, TX
- La Quinta Inn & Suites - Fort Worth, TX
- Days Inn - Weldon, NC
- Super 8 - Raleigh, NC
- Baymont Inn - Kingsland, GA
- Baymont Inn and Suites - Henderson, NC
- Baymont Inn and Suites - Albany, GA
- Microtel Inn and Suites - Greenville, NC
- Microtel Inn and Suites - Raleigh, NC
- Wingate - Greensboro, NC
- Wingate - Dublin, VA
- Wingate - Garner, NC

## WYNDHAM TRADEMARK BOUTIQUE COLLECTION

- Hotel Vervana - Bennington, VT





BRANDS WE SERVE



AND MANY MORE TO COME...





# FEATURED PROJECT



SPRINGHILL SUITES



DURHAM, NC







FEATURED PROJECT



TOWNEPLACE SUITES

**Marriott**

---

LA - Baton Rouge South







FEATURED PROJECT



LA QUINTA INN AND SUITES



SELMA, NC







## FEATURED PROJECT



## HAMPTON INN AND SUITES



CLEBURNE, TX









## FEATURED PROJECT



## HOLIDAY INN EXPRESS



COCKRELL HILL, TX



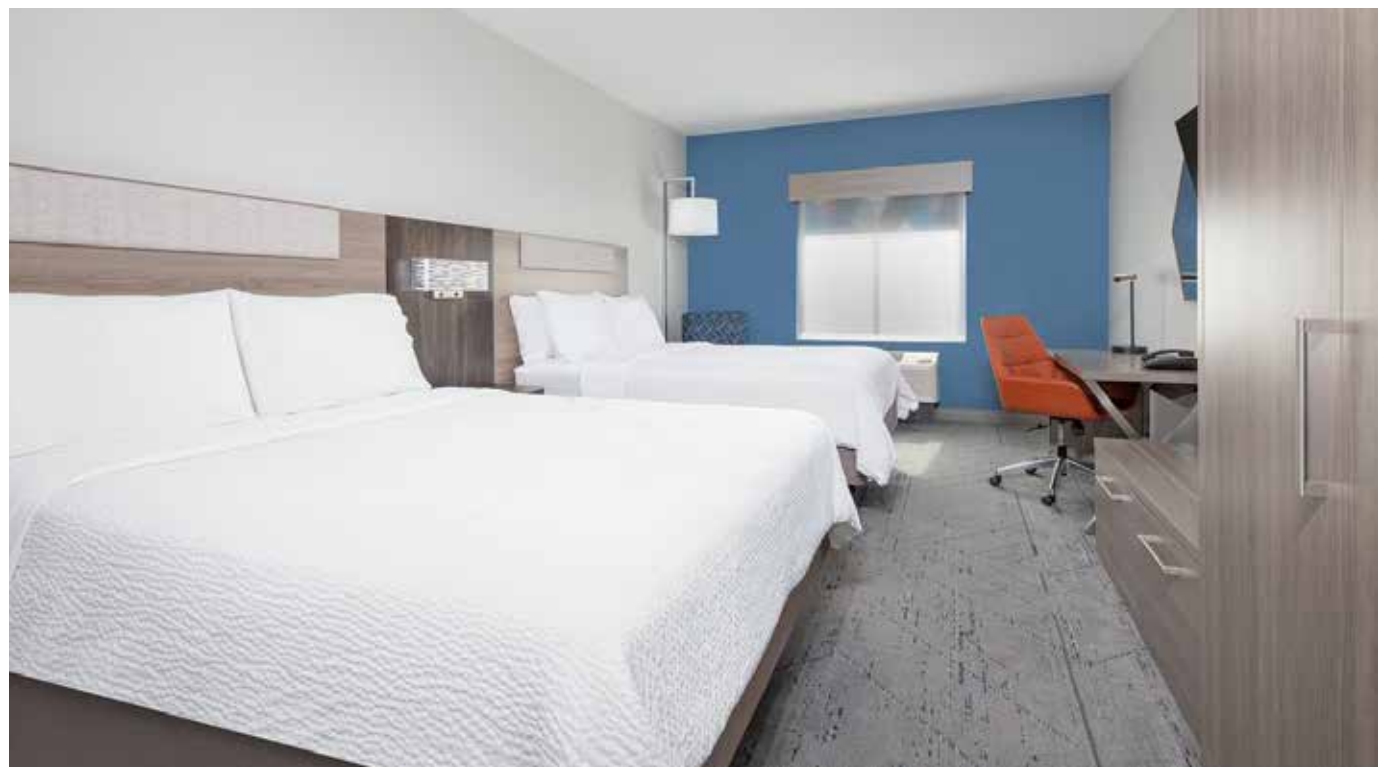



**COURTYARD**  
BY MARRIOTT

MONROEVILLE, PA







DOUBLETREE  
by Hilton™

FORT WORTH, TX

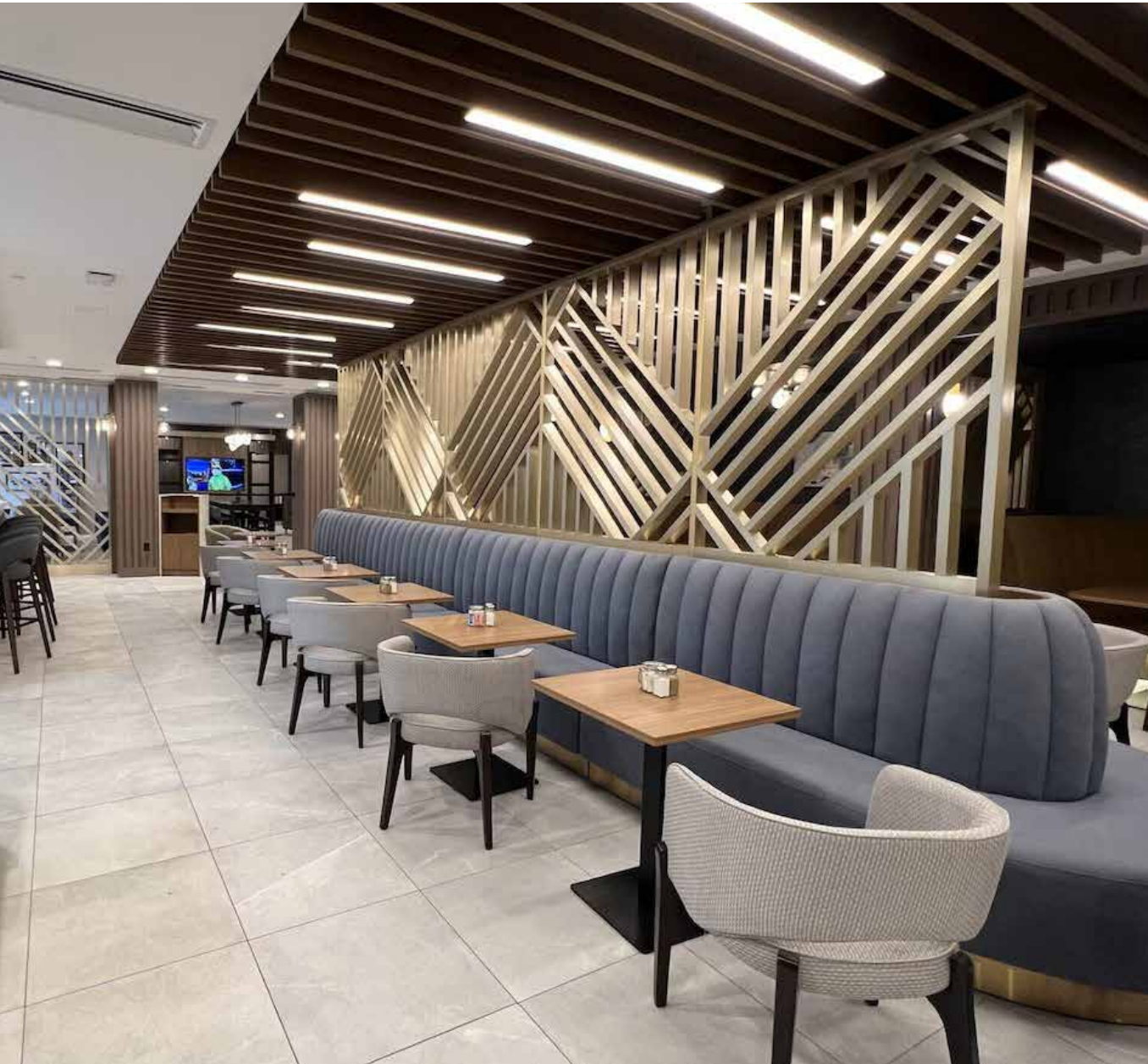





DOUBLETREE  
by Hilton™

WEST CHASE, TX

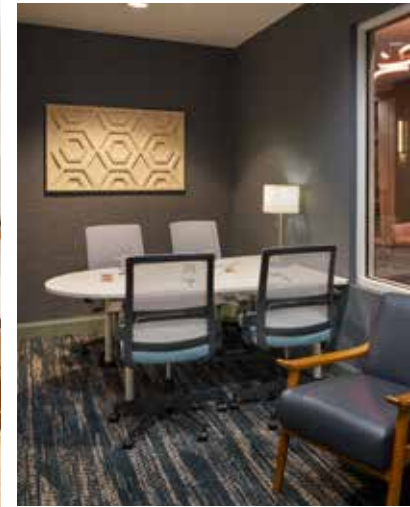







CROCKREL HILL, TX



TIME IS  
THE SNACKS ARE





MORRISVILLE, NC





THE HOTEL  
**LAUREL**

BENNINGTON, VT











FEEL FREE TO CONNECT WITH





5920 S. Miami Blvd, Suite 202  
Morrisville, NC 27560  
919-589-8855  
[info@jmhs-llc.com](mailto:info@jmhs-llc.com)  
[www.jmhs-llc.com](http://www.jmhs-llc.com)